

Discovery kit for STM32F429/439 lines

**Introduction**

The STM32F429 Discovery kit (32F429IDISCOVERY) helps you to discover the high performance of the STM32F4 series and to develop your applications. It is based on an STM32F429ZIT6 and includes an ST-LINK/V2 embedded debug tool interface, 2.4" TFT LCD, SDRAM 64 Mbits, Gyroscope ST MEMS, LEDs, pushbuttons and a USB OTG micro-B connector.

**Figure 1. STM32F429 Discovery board**

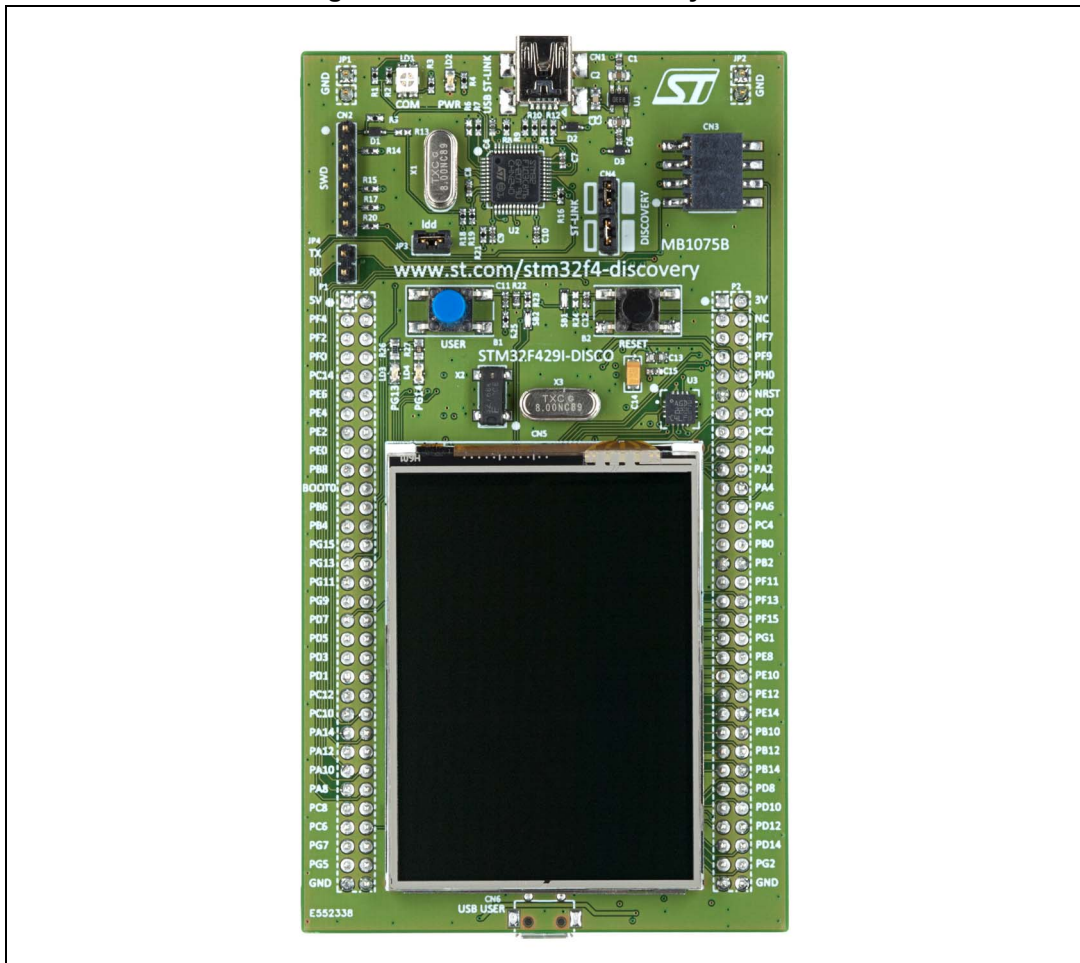

# Contents

<b>1</b>	<b>Conventions</b> .....	<b>3</b>
<b>2</b>	<b>Quick start</b> .....	<b>4</b>
2.1	Getting started .....	4
2.2	System requirements .....	4
2.3	Development toolchain supporting the STM32F429 Discovery kit .....	4
2.4	Order code .....	4
<b>3</b>	<b>Features</b> .....	<b>5</b>
<b>4</b>	<b>Hardware layout</b> .....	<b>6</b>
4.1	STM32F429ZIT6 microcontroller .....	9
4.2	Embedded ST-LINK/V2 .....	12
4.2.1	Using ST-LINK/V2 to program/debug the STM32F429ZIT6 on board ..	13
4.2.2	Using ST-LINK/V2 to program/debug an external STM32 application ..	14
4.3	Power supply and power selection .....	15
4.4	LEDs .....	15
4.5	Pushbuttons .....	15
4.6	USB OTG supported .....	16
4.7	Gyroscope MEMS (ST MEMS L3GD20) .....	16
4.8	TFT LCD (Thin-film-transistor liquid-crystal display) .....	16
4.9	64-Mbit SDRAM (1Mbit x 16-bit x 4-bank) .....	16
4.10	JP3 (Idd) .....	16
4.11	OSC clock .....	17
4.11.1	OSC clock supply .....	17
4.11.2	OSC 32 KHz clock supply .....	17
4.12	Solder bridges .....	18
4.13	Extension connectors .....	19
<b>5</b>	<b>Mechanical drawing</b> .....	<b>26</b>
<b>6</b>	<b>Electrical schematics</b> .....	<b>27</b>

**7      Revision history ..... 34**

## List of tables

Table 1.	ON/OFF conventions .....	3
Table 2.	Features and benefits .....	9
Table 3.	Jumper states .....	12
Table 4.	Debug connector CN2 (SWD) .....	14
Table 5.	Solder bridges .....	18
Table 6.	MCU pin description versus board function .....	19
Table 7.	Document revision history .....	34

## List of figures

Figure 1.	STM32F429 Discovery board	1
Figure 1.	Hardware block diagram	6
Figure 2.	Top layout	7
Figure 3.	Bottom layout	8
Figure 4.	STM32F429ZIT6 package	9
Figure 5.	STM32F429ZIT6 block diagram	11
Figure 6.	Typical configuration	12
Figure 7.	STM32F429 Discovery board connections image	13
Figure 8.	ST-LINK/V2 connections image	14
Figure 9.	STM32F429 Discovery board mechanical drawing	26
Figure 10.	STM32F429 Discovery board	27
Figure 11.	ST-LINK/V2 (SWD only)	28
Figure 12.	USB OTG_FS	29
Figure 13.	SDRAM 64 Mbits	30
Figure 14.	STM32F429ZIT6 MCU	31
Figure 15.	Peripherals	32
Figure 16.	LCD 2.4"	33

# 1 Conventions

[Table 1](#) provides the definition of some conventions used in the present document.

**Table 1. ON/OFF conventions**

Convention	Definition
Jumper JPx ON	Jumper fitted
Jumper JPx OFF	Jumper not fitted
Solder bridge SBx ON	SBx connections closed by solder
Solder bridge SBx OFF	SBx connections left open

## 2 Quick start

The STM32F429 Discovery is a low-cost and easy-to-use development kit to quickly evaluate and start a development with an STM32F4 series microcontroller.

Before installing and using the product, please accept the Evaluation Product License Agreement from [www.st.com/stm32f4-discovery](http://www.st.com/stm32f4-discovery).

For more information on the STM32F429 Discovery board and for demonstration software, visit [www.st.com/stm32f4-discovery](http://www.st.com/stm32f4-discovery).

### 2.1 Getting started

Follow the sequence below to configure the STM32F429 Discovery board and launch the DISCOVER application:

1. Ensure that the jumpers JP3 and CN4 are set to "on" (Discovery mode).
2. Connect the STM32F429 Discovery board to a PC using a USB cable type A/mini-B through the USB ST-LINK connector CN1, to power the board. The LEDs LD2 (PWR) and LD1 (COM).
3. The following applications are available on the screen:
  - Clock/Calendar and Game
  - Video Player and Image Browser (play videos and view images from the USB mass storage connected to CN6)
  - Performance monitor (watch the CPU load and run a graphical benchmark)
  - System Info
4. The demo software, as well as other software examples that allow you to discover the STM32 F4 series features, are available on [www.st.com/stm32f4-discovery](http://www.st.com/stm32f4-discovery).
5. Develop your own applications starting from the examples.

### 2.2 System requirements

- Windows PC (XP, Vista, 7)
- USB type A to mini-B cable

### 2.3 Development toolchain supporting the STM32F429 Discovery kit

- Altium: TASKING™ VX-Toolset
- Atollic: TrueSTUDIO
- IAR: EWARM
- Keil™: MDK-ARM

### 2.4 Order code

To order the STM32F429 Discovery kit, use the STM32F429I-DISCO order code.

### 3 Features

The STM32F429 Discovery board offers the following features:

- STM32F429ZIT6 microcontroller featuring 2 MB of Flash memory, 256 KB of RAM in an LQFP144 package
- On-board ST-LINK/V2 with selection mode switch to use the kit as a standalone ST-LINK/V2 (with SWD connector for programming and debugging)
- Board power supply: through the USB bus or from an external 3 V or 5 V supply voltage
- L3GD20, ST MEMS motion sensor, 3-axis digital output gyroscope
- TFT LCD (Thin-film-transistor liquid-crystal display) 2.4", 262K colors RGB, 240 x 320 dots
- SDRAM 64 Mbits (1 Mbit x 16-bit x 4-bank) including an AUTO REFRESH MODE, and a power-saving
- Six LEDs:
  - LD1 (red/green) for USB communication
  - LD2 (red) for 3.3 V power-on
  - Two user LEDs:  
LD3 (green), LD4 (red)
  - Two USB OTG LEDs:  
LD5 (green) VBUS and LD6 (red) OC (over-current)
- Two pushbuttons (user and reset)
- USB OTG with micro-AB connector
- Extension header for LQFP144 I/Os for a quick connection to the prototyping board and an easy probing



## 4 Hardware layout

The STM32F429 Discovery board has been designed around the STM32F429ZIT6 microcontroller in a 144-pin LQFP package.

*Figure 1* illustrates the connections between the STM32F429ZIT6 and its peripherals (ST-LINK/V2, pushbutton, LED, USB OTG, Gyroscope ST MEMS, Accelerometer + Magnetometer ST MEMS, and connectors).

*Figure 2* and *Figure 3* help you to locate these features on the STM32F429 Discovery board.

**Figure 1. Hardware block diagram**

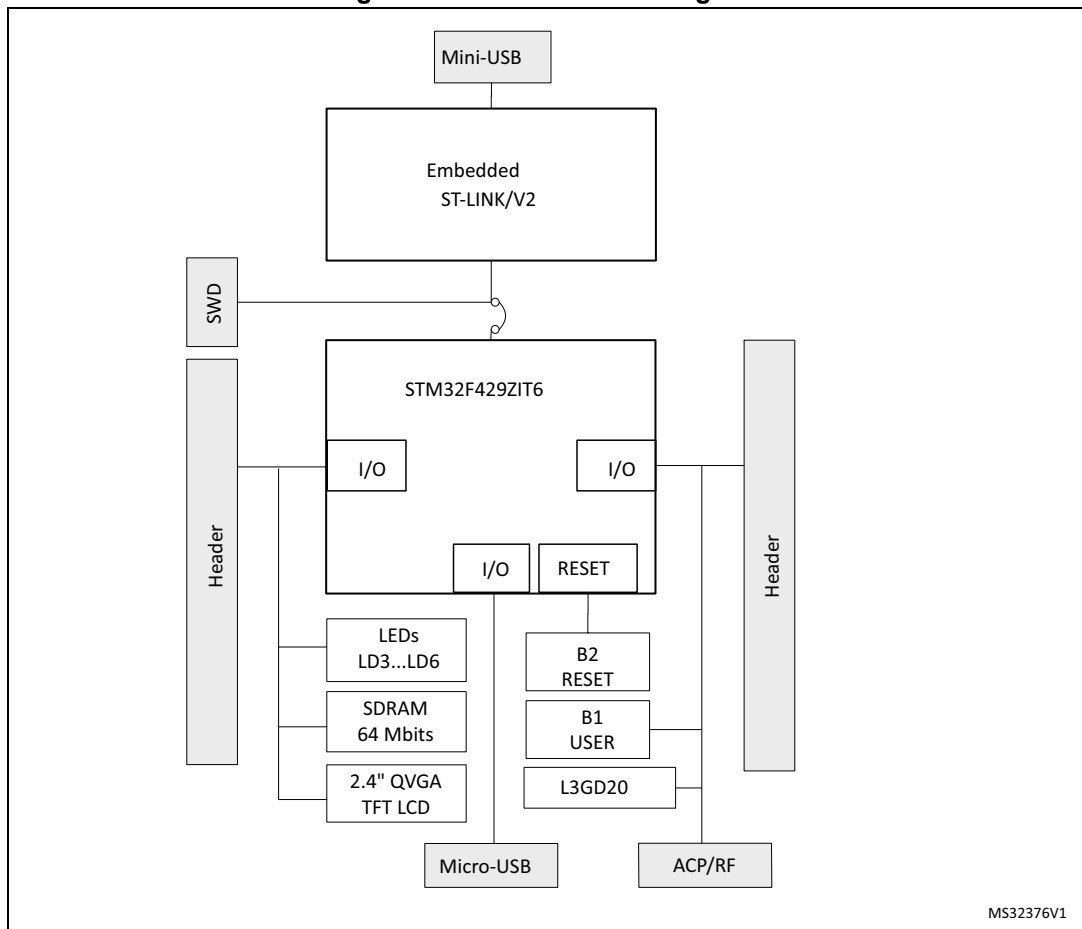

Figure 2. Top layout

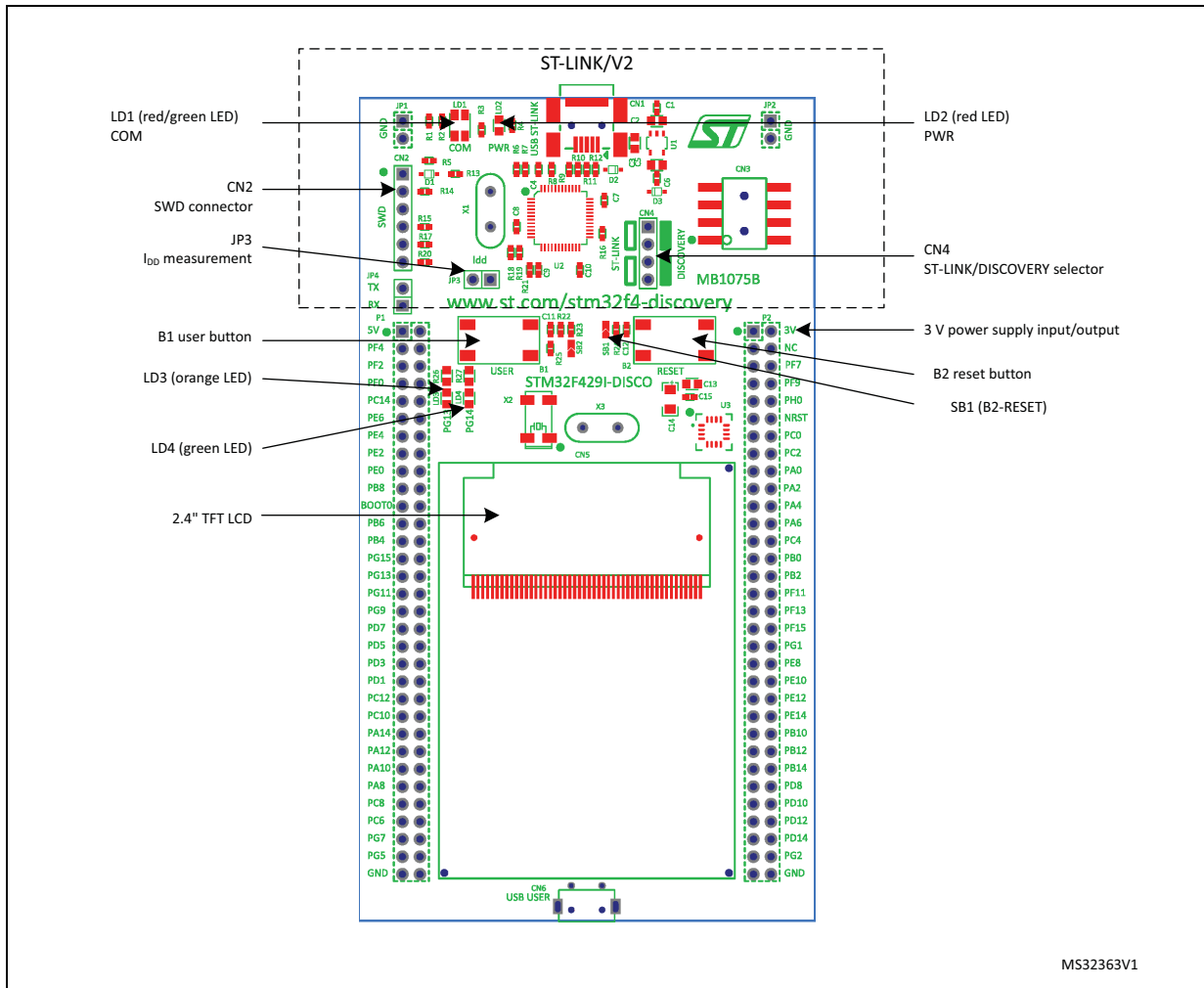
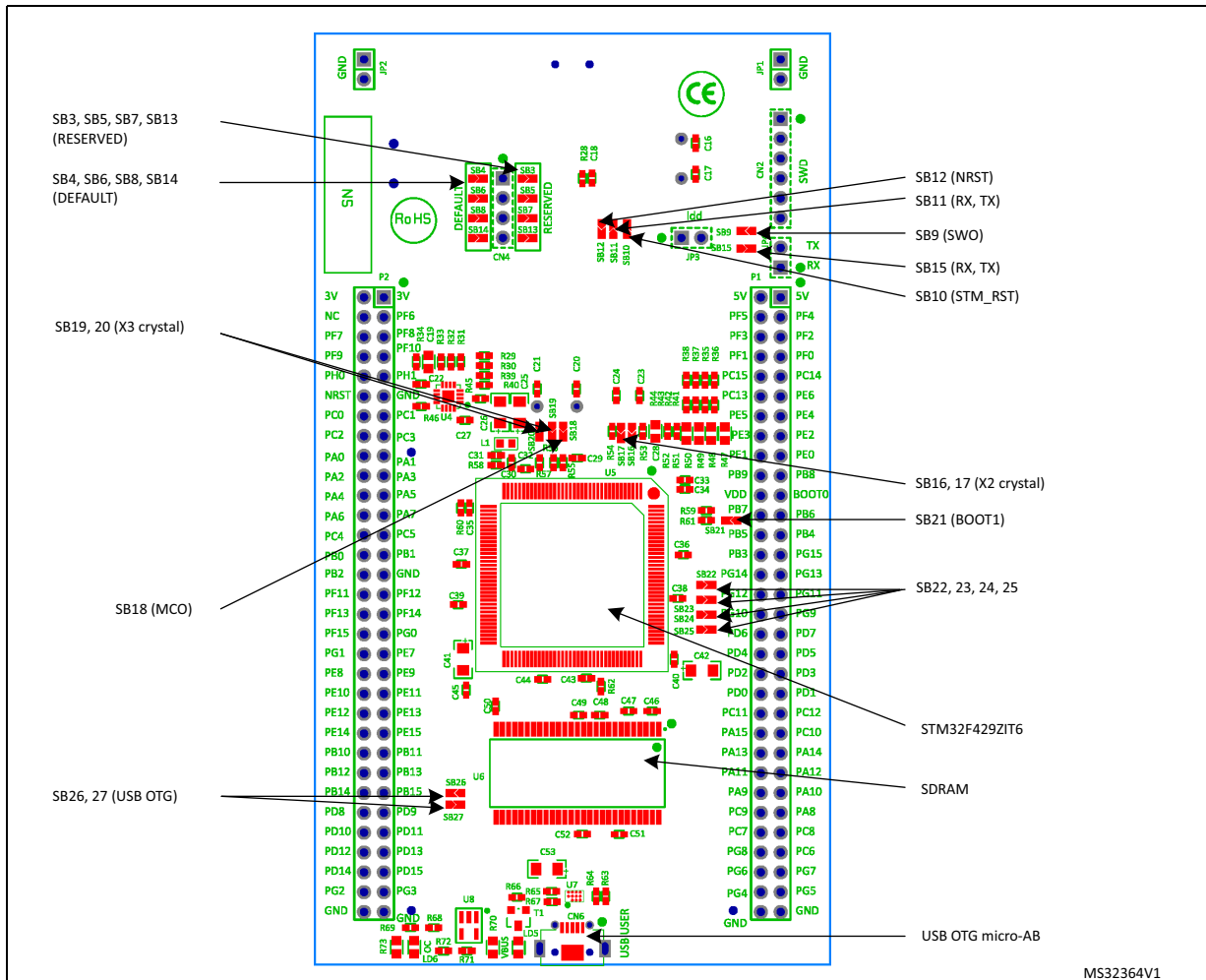

Figure 3. Bottom layout



MS32364V1

### 4.1 STM32F429ZIT6 microcontroller

This ARM Cortex-M4 32-bit MCU with FPU has 225 DMIPS, up to 2 MB Flash/256 + 4 KB RAM, USB OTG HS/FS, Ethernet, 17 TIMs, 3 ADCs, 20 comm. interfaces, a camera and an LCD-TFT, 1.7-3.6 V operation.

**Figure 4. STM32F429ZIT6 package**

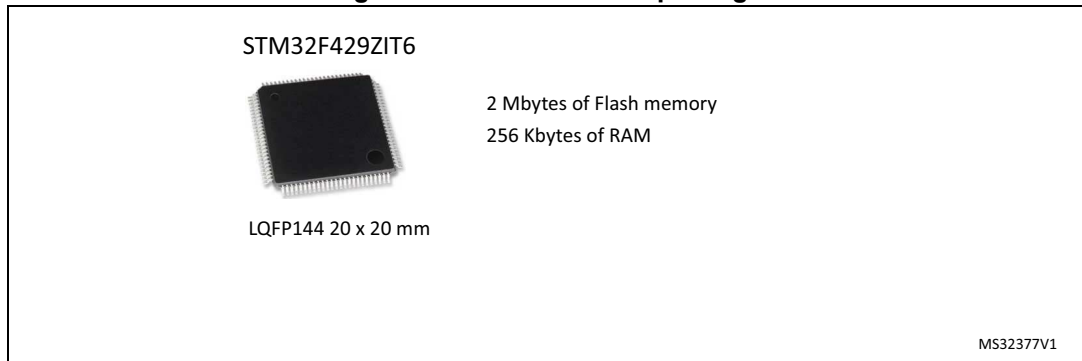

This device provides the following benefits (see [Table 2](#)).

**Table 2. Features and benefits**

Features	Benefits
<p><b>High performance</b></p> <ul style="list-style-type: none"> <li>– Up to 180 MHz/225 DMIPS Cortex-M4 with single cycle DSP MAC and floating point unit</li> <li>– CoreMark score: 608 at 180 MHz</li> <li>– CoreMark/MHz: 3.37</li> </ul>	<ul style="list-style-type: none"> <li>– Boosted execution of control algorithms</li> <li>– More features for your applications</li> <li>– Ease of use</li> <li>– Better code efficiency</li> <li>– Faster time to market</li> <li>– Elimination of scaling and saturation</li> <li>– Easier support for meta-language tools</li> </ul>
<p><b>Maximum integration</b></p> <ul style="list-style-type: none"> <li>– Up to 2 Mbytes of on-chip dual bank Flash memory, up to 256 Kbytes of SRAM, reset circuit, internal RCs, PLLs, ultra-small packages (WLCSP)</li> </ul>	<ul style="list-style-type: none"> <li>– Read while write operations support</li> <li>– More features in space-constrained applications</li> <li>– Use of high-level languages: Java, .Net</li> </ul>
<p><b>Designed for high performance and ultra-fast data transfers</b></p> <ul style="list-style-type: none"> <li>– ART Accelerator™: memory accelerator</li> <li>– Chrom-ART Accelerator™: graphic accelerator (rectangle filling, rectangle copy with pixel format conversion and blending)</li> </ul>	<ul style="list-style-type: none"> <li>– Performance equivalent to zero-wait execution from Flash</li> <li>– Graphic content is created twice as fast and independently from the CPU</li> </ul>
<ul style="list-style-type: none"> <li>– 32-bit, 7-layer AHB bus matrix with up to 10 masters and 8 slaves including 3 blocks of SRAM</li> <li>– Multi DMA controllers: 2 general-purpose, 1 for USB HS, one for Ethernet</li> </ul>	<p>Concurrent execution and data transfer</p>
<ul style="list-style-type: none"> <li>– One 4th SRAM block dedicated to the core</li> </ul>	<p>Simplified resource allocation</p>
<ul style="list-style-type: none"> <li>– Flexible memory interface with SDRAM support: up to 90 MHz, 32-bit parallel</li> </ul>	<ul style="list-style-type: none"> <li>– High bandwidth for external memories</li> <li>– Cost-effective external RAM</li> </ul>

**Table 2. Features and benefits (continued)**

Features	Benefits
<p><b>Outstanding power efficiency</b></p> <ul style="list-style-type: none"> <li>– Ultra-low dynamic power in Run mode: 260 <math>\mu</math>A/MHz at 180 MHz running CoreMark benchmark from Flash memory (peripherals off)</li> <li>– RTC &lt;1 <math>\mu</math>A typ in V<sub>BAT</sub> mode</li> <li>– Down to 100 <math>\mu</math>A typ in Stop mode</li> <li>– 3.6 V down to 1.7 V V<sub>DD</sub></li> <li>– 1.2 V voltage regulator with power scaling capability</li> </ul>	<p>Extra flexibility to reduce power consumption for applications requiring both high-processing and low-power performance when running at low voltage or on a rechargeable battery</p>
<p><b>Superior and innovative peripherals and connectivity</b></p> <ul style="list-style-type: none"> <li>– Connectivity: camera interface, crypto/hash HW processor with AES GCM and CCM support, and SHA-256</li> <li>– Ethernet MAC10/100 with IEEE 1588 v2 support, 2 USB OTG (one with HS support)</li> <li>– Up to 20 communication interfaces (including 4x USART + 4x UART, 6x SPI, 3x I<sup>2</sup>C with digital filter, 2x CAN, SDIO)</li> <li>– USART at 11.25 Mbit/s; SPI at 45 Mbit/s</li> </ul>	<p>New possibilities to connect and communicate high-speed data</p>
<p>Audio:</p> <ul style="list-style-type: none"> <li>– dedicated audio PLL, 2x I<sup>2</sup>S and 1x SAI with TDM<sup>(1)</sup> support</li> </ul>	<p>High-quality multi-channel audio support</p>
<ul style="list-style-type: none"> <li>– LCD TFT controller</li> <li>– Up to SVGA format (800 x 600)</li> <li>– Up to 24-bit RGB parallel pixel output</li> <li>– 2-layer support with blending</li> </ul>	<p>Support for cost-effective standard displays</p>
<p>Analog:</p> <ul style="list-style-type: none"> <li>– 2x 12-bit DACs, 3x 12-bit ADCs reaching 7.2 MSPS in interleaved mode</li> <li>– Up to 17 timers: 16 and 32 bits running up to 180 MHz</li> </ul>	<p>More precision thanks to high resolution</p>
<p><b>High integration</b></p> <ul style="list-style-type: none"> <li>– WLCSP143 4.5 x 5.5 mm, 2-Mbyte Flash/256-Kbyte SRAM)</li> </ul>	<p>Smaller board space allowing for smaller applications</p>
<p><b>Extensive tools and software solutions</b></p> <ul style="list-style-type: none"> <li>– Hardware sector protection with execute only access</li> <li>– Various IDE, starter kits, libraries, RTOS and stacks, either open source or provided by ST or 3rd parties, including the ARM CMSIS DSP library optimized for Cortex-M4 instructions</li> </ul>	<ul style="list-style-type: none"> <li>– Software IP protection</li> <li>– A wide choice within the STM32 ecosystem to develop your applications</li> </ul>

1. TDM: time division multiplex

Figure 5. STM32F429ZIT6 block diagram

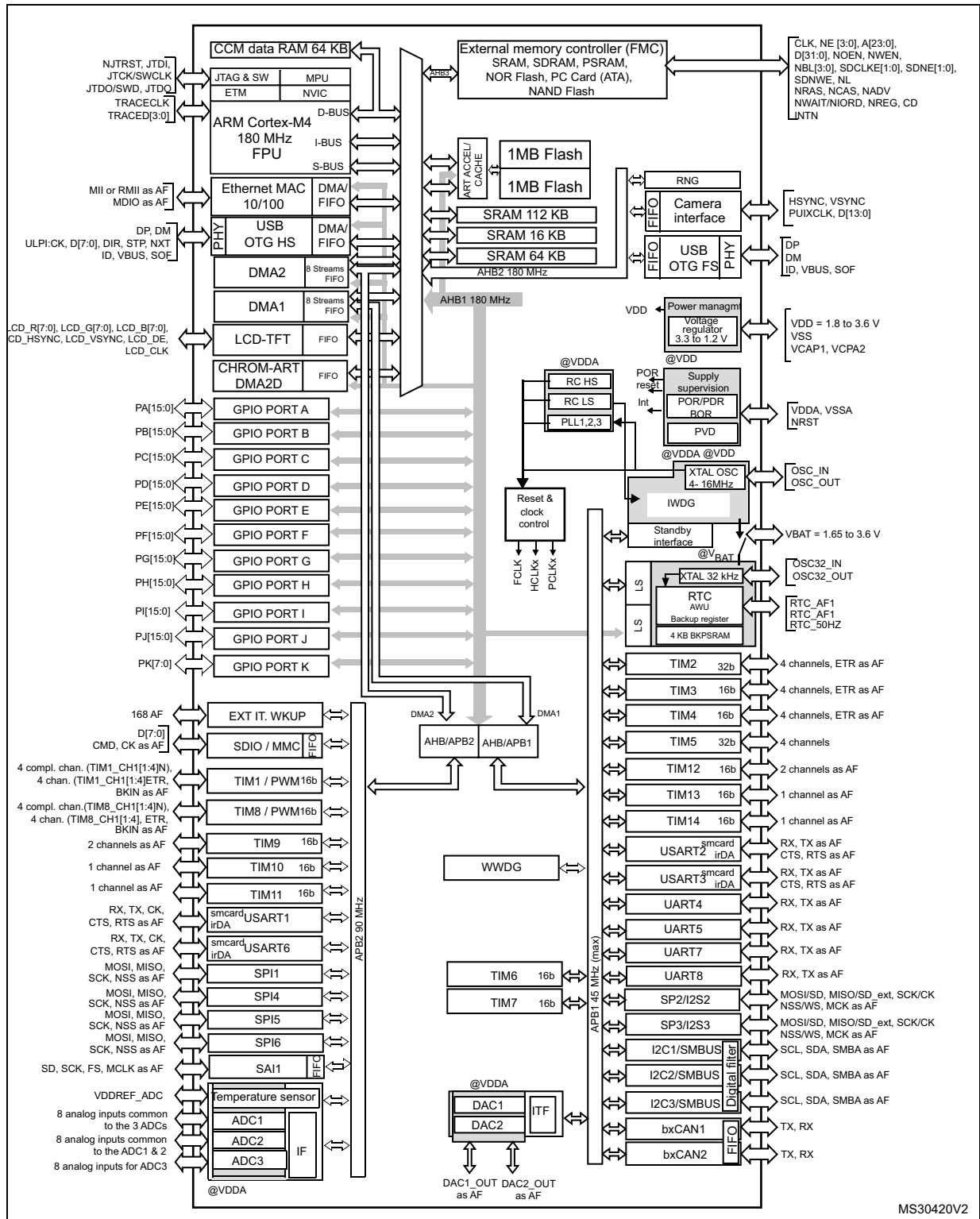

MS30420V2

## 4.2 Embedded ST-LINK/V2

The ST-LINK/V2 programming and debugging tool is integrated on the STM32F429 Discovery board. The embedded ST-LINK/V2 can be used in 2 different ways according to the jumper states (see [Table 3](#)):

- Program/debug the MCU on board,
- Program/debug an MCU in an external application board using a cable connected to SWD connector CN3.

The embedded ST-LINK/V2 supports only SWD for STM32 devices. For information about debugging and programming features, refer to user manual UM1075 (ST-LINK/V2 in-circuit debugger/programmer for STM8 and STM32) which describes in detail all the ST-LINK/V2 features.

**Figure 6. Typical configuration**

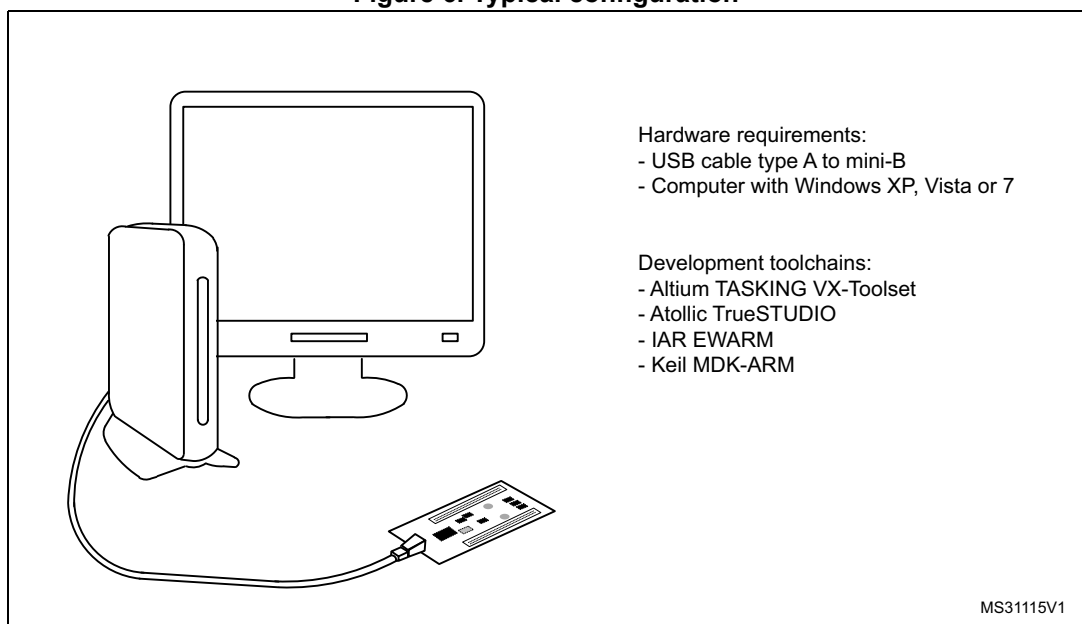

**Table 3. Jumper states**

Jumper state	Description
Both CN4 jumpers ON	ST-LINK/V2 functions enabled for on-board programming (default)
Both CN4 jumpers OFF	ST-LINK/V2 functions enabled for application through external CN3 connector (SWD supported)

### 4.2.1 Using ST-LINK/V2 to program/debug the STM32F429ZIT6 on board

To program the STM32F429ZIT6 on board, simply plug in the two jumpers on CN4, as shown in *Figure 7* in red, but do not use the CN3 connector as that could disturb the communication with the STM32F429ZIT6 of the STM32F429 Discovery board.

Figure 7. STM32F429 Discovery board connections image

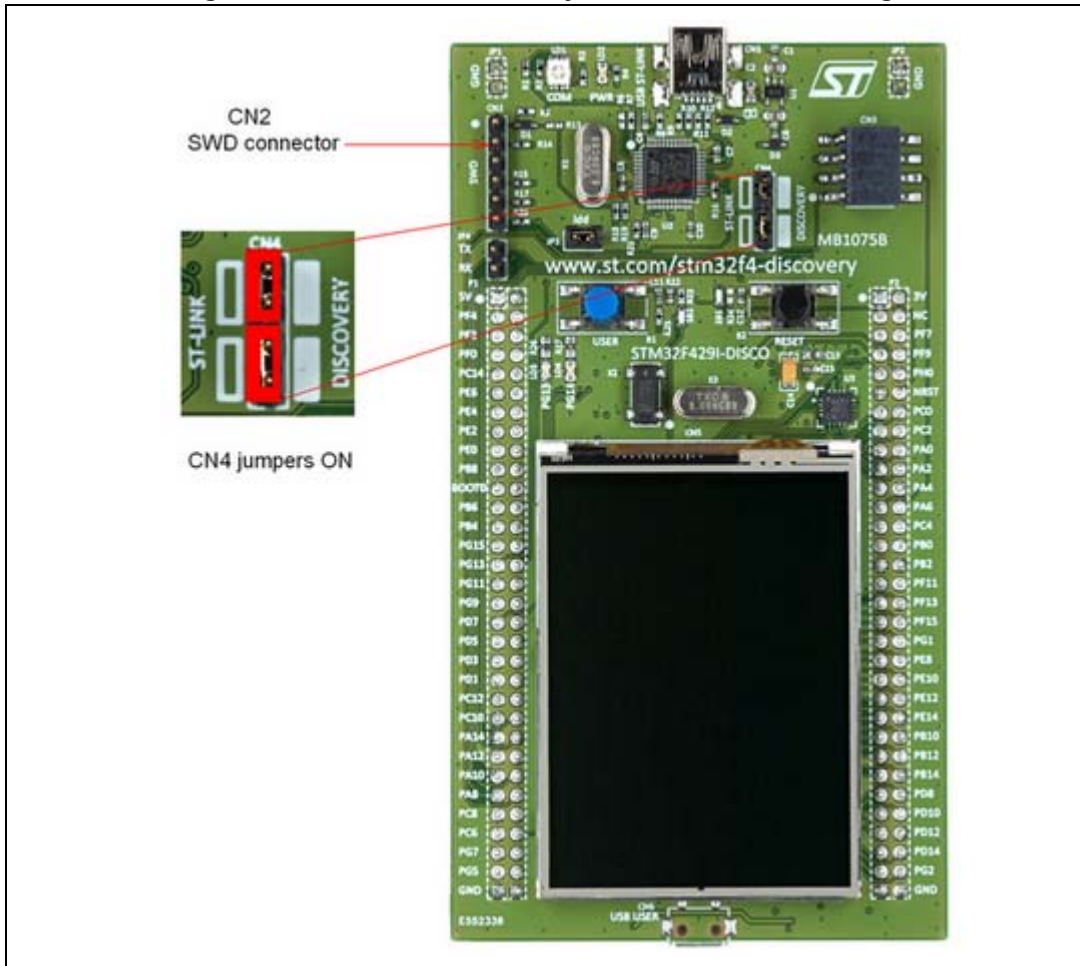



### 4.2.2 Using ST-LINK/V2 to program/debug an external STM32 application

It is very easy to use the ST-LINK/V2 to program the STM32 on an external application. Simply remove the two jumpers from CN4 as shown in [Figure 8](#), and connect your application to the CN3 debug connector according to [Table 4](#).

*Note:* SB7 must be OFF if you use CN2 pin 5 in your external application.

**Table 4. Debug connector CN2 (SWD)**

Pin	CN2	Designation
1	VDD_TARGET	VDD from application
2	SWCLK	SWD clock
3	GND	Ground
4	SWDIO	SWD data input/output
5	NRST	RESET of target MCU
6	SWO	Reserved

**Figure 8. ST-LINK/V2 connections image**

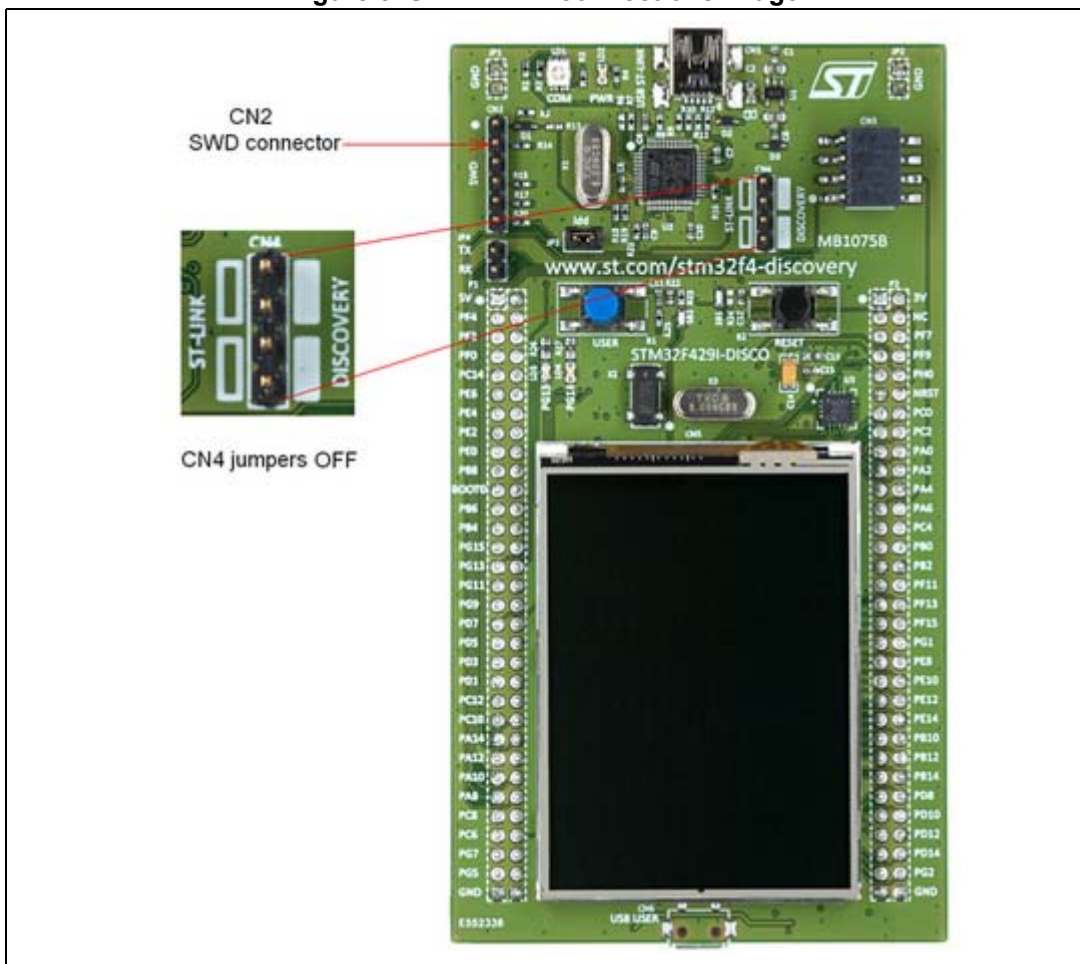

### 4.3 Power supply and power selection

The power supply is provided either by the host PC through the USB cable, or by an external 5 V power supply.

The D1 and D2 diodes protect the 5 V and 3 V pins from external power supplies:

- 5 V and 3 V can be used as output power supplies when another application board is connected to pins P1 and P2.  
In this case, the 5 V and 3 V pins deliver a 5 V or 3 V power supply and the power consumption must be lower than 100 mA.
- 5 V and 3 V can also be used as input power supplies, e.g. when the USB connectors are not connected to the PC.  
In this case, the STM32F429 Discovery board must be powered by a power supply unit or by an auxiliary equipment complying with standard EN-60950-1: 2006+A11/2009, and must be Safety Extra Low Voltage (SELV) with limited power capability.

*Note: The board can also be powered through the USB USER connector and is protected by D4 and D5 diodes when both USBs are connected (in which case, the 5 V power is around 4.4 volts).*

### 4.4 LEDs

- LD1 COM:  
LD1 default status is red. LD1 turns to green to indicate that communications are in progress between the PC and the ST-LINK/V2.
- LD2 PWR:  
The red LED indicates that the board is powered.
- User LD3:  
The green LED is a user LED connected to the I/O PG13 of the STM32F429ZIT6.
- User LD4:  
The red LED is a user LED connected to the I/O PG14 of the STM32F429ZIT6.
- User LD5:  
The green LED indicates when VBUS is present on CN6 and is connected to PB13 of the STM32F429ZIT6.
- User LD6:  
The red LED indicates an overcurrent from VBUS of CN6 and is connected to the I/O PC5 of the STM32F429ZIT6.

### 4.5 Pushbuttons

- B1 USER:  
User and Wake-Up button connected to the I/O PA0 of the STM32F429ZIT6.
- B2 RESET:  
The pushbutton connected to NRST is used to RESET the STM32F429ZIT6.

## 4.6 USB OTG supported

The STM32F429ZIT6 is used to drive only USB OTG full speed on this board. The USB micro-AB connector (CN6) allows the user to connect a host or device component, such as a USB key, mouse, and so on.

Two LEDs are dedicated to this module:

- LD5 (green LED) indicates when VBUS is active
- LD6 (red LED) indicates an overcurrent from a connected device.

## 4.7 Gyroscope MEMS (ST MEMS L3GD20)

The L3GD20 is an ultra-compact, low-power, three-axis angular rate sensor. It includes a sensing element and an IC interface able to provide the measured angular rate to the external world through the I2C/SPI serial interface.

The L3GD20 has dynamically user-selectable full scales of  $\pm 250$  dps/500 dps/ $\pm 2000$  dps and is capable of measuring rates.

The STM32F429ZIT6 MCU controls this motion sensor through the SPI interface.

## 4.8 TFT LCD (Thin-film-transistor liquid-crystal display)

The TFT LCD is a 2.41" display of 262 K colors. Its definition is QVGA (240 x 320 dots) and is directly driven by the STM32F429ZIT6 using the RGB protocol. It includes the ILI9341 LCD controller and can operate with a  $2.8 \pm 0.3$  V voltage.

The STM32F429ZIT6 MCU controls this motion sensor through the SPI interface.

## 4.9 64-Mbit SDRAM (1Mbit x 16-bit x 4-bank)

The 64-Mbit SDRAM is a high speed CMOS, dynamic random-access memory designed to operate in 3.3 V memory systems containing 67,108,864 bits. It is internally configured as a quad-bank DRAM with a synchronous interface. Each 16,777,216-bit bank is organized as 4,096 rows by 256 columns by 16 bits. The 64-Mbit SDRAM includes an AUTO REFRESH MODE, and a power-saving, power-down mode. All signals are registered on the positive edge of the clock signal, CLK.

The STM32F429ZIT6 MCU reads and writes data at 80 MHz.

## 4.10 JP3 (Idd)

Jumper JP3, labeled Idd, allows the consumption of STM32F429ZIT6 to be measured by removing the jumper and connecting an ammeter.

- Jumper on: STM32F429ZIT6 is powered (default).
- Jumper off: an ammeter must be connected to measure the STM32F429ZIT6 current, (if there is no ammeter, the STM32F429ZIT6 is not powered).

## 4.11 OSC clock

### 4.11.1 OSC clock supply

The following information indicates all configurations for clock supply selection.

- **MCO from ST-LINK** (from MCO of the STM32F429ZIT6)  
This frequency cannot be changed, it is fixed at 8 MHz and connected to PH0-OSC\_IN of the STM32F429ZIT6. The configuration needed is:
  - SB18 closed, SB19 open, R56 removed
  - SB20, R57, C20, C21, X3 = don't care
- **Oscillator onboard** (from X3 crystal)  
For typical frequencies and its capacitors and resistors, please refer to the STM32F429ZIT6 Datasheet. The configuration needed is:
  - SB18, SB19, SB20 open
  - -R56, R57, C20, C21, X3 soldered
- **Oscillator from external PH0** (from external oscillator through pin 10 of the P2 connector)  
The configuration needed is:
  - SB19 closed, SB18 open, R56 removed
  - SB20, R57, C20, C21, X3 = don't care
- **No external oscillator** (from Internal oscillator HSI only).  
PH0 and PH1 can be used as GPIO. The configuration needed is:
  - SB18 open, SB19 closed, SB20 closed, R56 removed, R57 removed
  - C20, C21, X3 = don't care

### 4.11.2 OSC 32 KHz clock supply

The following information indicates all configurations for the 32 kHz clock supply selection.

- **Oscillator on board** (from X2 Crystal, not provided).  
The configuration needed is:
  - SB16 open, SB17 open.
  - R53, R54, C23, C24, X2 soldered.
- **Oscillator from external PC14** (from external oscillator through pin 9 of P1 connector)  
The configuration needed is:
  - SB16 closed, R53 removed
  - SB17, R54, C23, C24, X2 = don't care
- **No external oscillator** (PC14 and PC15 can be used as GPI).  
The configuration needed is:
  - SB16 closed, SB17 closed, R53 removed, R54 removed.
  - C23, C24, X2 = don't care.

## 4.12 Solder bridges

**Table 5. Solder bridges**

Bridge	State <sup>(1)</sup>	Description
SB19,20 (X3 crystal)	<b>OFF</b>	X3, C20, C21, R56 and R57 provide a clock. PH0, PH1 are disconnected from P2
	ON	PH0, PH1 are connected to P2. Remove only R56 and R57
SB4,6,8,14 (default)	<b>ON</b>	Reserved, do not modify
SB3,5,7,13 (reserved)	<b>OFF</b>	Reserved, do not modify
SB22,23,24,25	<b>OFF</b>	Reserved, do not modify
SB16,17 (X2 crystal)	<b>OFF</b>	X2, C23, C24, R53 and R54 deliver a 32 KHz clock. PC14, PC15 are not connected to P2
	ON	PC14, PC15 are only connected to P2 Remove only R53 and R54
SB1 (B2-RESET)	<b>ON</b>	B2 Push Button is connected to NRST of STM32F429ZIT6
	OFF	B2 Push Button is not connected to NRST of STM32F429ZIT6
SB2 (B1-USER)	<b>ON</b>	B1 Push Button is connected to PA0
	OFF	B1 Push Button is not connected to PA0
SB11,15 (RX,TX)	<b>OFF</b>	Reserved, do not modify
	ON	Reserved, do not modify
SB12 (NRST)	<b>ON</b>	NRST signal of connector CN2 is connected to NRST of STM32F429ZIT6
	OFF	NRST signal is not connected
SB9 (SWO)	<b>OFF</b>	SWO signal is not connected
	ON	SWO signal of connector CN3 is connected to PB3
SB10 (STM_RST)	<b>OFF</b>	No incidence on NRST signal of STM32F429ZIT6
	ON	NRST signal of STM32F429ZIT6 is connected to GND
SB21 (BOOT0)	<b>ON</b>	BOOT0 signal of STM32F429ZIT6 is at level "0" through 510 $\Omega$ pull-down
	OFF	BOOT0 signal of STM32F429ZIT6 is at level "1" through 10 K $\Omega$ pull-up (not provided)
SB26,27 (USB OTG)	<b>OFF</b>	PB14 and PB15 are only used for USB OTG and not connected to P2 to avoid noise
	ON	PB14 and PB15 are connected to P2.
SB18 (MCO)	<b>OFF</b>	MCO signal of STM32F429ZIT6 is not used
	ON	MCO clock signal from STM32F429ZIT6 is connected to OSC_IN of STM32F429ZIT6

1. Default SBx state is shown in bold.

### 4.13 Extension connectors

The male headers P1 and P2 can connect the STM32F429 Discovery board to a standard prototyping/wrapping board. STM32F429ZIT6 GPI/Os are available on these connectors. P1 and P2 can also be probed by an oscilloscope, a logical analyzer or a voltmeter.

**Table 6. MCU pin description versus board function (page 1 of 7)**

MCU pin		Board function																	
Main function	LQFP144	System	SDRAM	LCD-TFT	LCD-RGB	LCD-SPI	L3GD20	USB	LED	Puchbutton	ACP/RF	Touch panel	Free I/O	Power supply	CN2	CN3	CN6	P1	P2
BOOT0	138	BOOT0																21	
NRST	25	NRST		RESET	RESET	RESET				B2					5				12
PA0	34									B1									18
PA1	35						INT1												17
PA2	36						INT2												20
PA3	37			DB3	B5														19
PA4	40			VSYNC	VSYNC														22
PA5	41																		21
PA6	42			DB6	G2														24
PA7	43										ACP_RST						4		23
PA8	100										SCL	SCL				3		53	
PA9	101																	52	
PA10	102																	51	
PA11	103			DB14	R4													50	
PA12	104			DB15	R5													49	
PA13	105	SWDIO													4			48	

Table 6. MCU pin description versus board function (page 2 of 7)

MCU pin		Board function																	
Main function	LQFP144	System	SDRAM	LCD-TFT	LCD-RGB	LCD-SPI	L3GD20	USB	LED	Puchbutton	ACP/RF	Touch panel	Free I/O	Power supply	CN2	CN3	CN6	P1	P2
PA14	109	SWCLK													2			47	
PA15	110											INT						46	
PB0	46			DB13	R3														28
PB1	47			DB16	R6														27
PB2	48	BOOT1																	30
PB3	133	SWO													6			28	
PB4	134																	25	
PB5	135		SDCKE1															26	
PB6	136		SDNE1															23	
PB7	137																	24	
PB8	139			DB4	B6													19	
PB9	140			DB5	B7													20	
PB10	69			DB8	G4														48
PB11	70			DB9	G5														47
PB12	73							ID									4		50
PB13	74							VBUS	Green								1		49
PB14	75							DM									2		52 <sup>(1)</sup>
PB15	76							DP									3		51 <sup>(2)</sup>
PC0	26		SDNWE																14

Table 6. MCU pin description versus board function (page 3 of 7)

MCU pin		Board function																	
Main function	LQFP144	System	SDRAM	LCD-TFT	LCD-RGB	LCD-SPI	L3GD20	USB	LED	Puchbutton	ACP/RF	Touch panel	Free I/O	Power supply	CN2	CN3	CN6	P1	P2
PC1	27						CS												13
PC2	28			CSX	CSX	CSX													16
PC3	29																		15
PC4	44							PSO											26
PC5	45							QC	Red										25
PC6	96			HSYNC	HSYNC													57	
PC7	97			DB10	G6													56	
PC8	98																	55	
PC9	99										SDA	SDA				1		54	
PC10	111			DB12	R2													45	
PC11	112																	44	
PC12	113																	43	
PC13	7																	12	
PC14	8	OSC32_IN																9	
PC15	9	OSC32_OUT																10	
PD0	114		D2															42	
PD1	115		D3															41	
PD2	116																	40	
PD3	117			DB11	G7													39	
PD4	118																	38	
PD5	119																	37	



Table 6. MCU pin description versus board function (page 4 of 7)

MCU pin		Board function																	
Main function	LQFP144	System	SDRAM	LCD-TFT	LCD-RGB	LCD-SPI	L3GD20	USB	LED	Puchbutton	ACP/RF	Touch panel	Free I/O	Power supply	CN2	CN3	CN6	P1	P2
PD6	122			DB0	B2													36	
PD7	123																	35	
PD8	77		D13																54
PD9	78		D14																53
PD10	79		D15																56
PD11	80			TE															55
PD12	81			RDX															58
PD13	82			WRX		DCX													57
PD14	85		D0																60
PD15	86		D1																59
PE0	141		NBL0															17	
PE1	142		NBL1															18	
PE2	1																	15	
PE3	2																	16	
PE4	3																	13	
PE5	4																	14	
PE6	5																	11	
PE7	58		D4																37
PE8	59		D5																40
PE9	60		D6																39
PE10	63		D7																42
PE11	64		D8																41
PE12	65		D9																44
PE13	66		D10																43
PE14	67		D11																46



Table 6. MCU pin description versus board function (page 5 of 7)

MCU pin		Board function																	
Main function	LQFP144	System	SDRAM	LCD-TFT	LCD-RGB	LCD-SPI	L3GD20	USB	LED	Puchbutton	ACP/RF	Touch panel	Free I/O	Power supply	CN2	CN3	CN6	P1	P2
PE15	68		D12																45
PF0	10		A0															7	
PF1	11		A1															8	
PF2	12		A2															5	
PF3	13		A3															6	
PF4	14		A4															3	
PF5	15		A5															4	
PF6	18																		3
PF7	19			DCX		SCL	SCK												6
PF8	20						MISO												5
PF9	21			SDA		SDI/SDO	MOSI												8
PF10	22			ENABLE	DE														7
PF11	49		SDNRAS																32
PF12	50		A6																31
PF13	53		A7																34
PF14	54		A8																33
PF15	55		A9																36
PG0	56		A10																35
PG1	57		A11																38
PG2	87																		62
PG3	88																		61
PG4	89		BA0															62	
PG5	90		BA1															61	

Table 6. MCU pin description versus board function (page 6 of 7)

MCU pin		Board function																	
Main function	LQFP144	System	SDRAM	LCD-TFT	LCD-RGB	LCD-SPI	L3GD20	USB	LED	Puchbutton	ACP/RF	Touch panel	Free I/O	Power supply	CN2	CN3	CN6	P1	P2
PG6	91			DB17	R7													60	
PG7	92			DOTLCK	CLK													59	
PG8	93		SDCLK															58	
PG9	124																	33	
PG10	125			DB7	G3													34	
PG11	126			DB1	B3													31	
PG12	127			DB2	B4													32	
PG13	128								Red Green									29	
PG14	129								Red									30	
PG15	132		SDNCAS															27	
PH0	23	OSC_IN																	10
PH1	24	OSC_OUT																	9
														VDD				22	
														3 V		5			1
														3 V					2
														5 V		8		1	
														5 V				2	
														GND	3	7	5	63	11

Table 6. MCU pin description versus board function (page 7 of 7)

MCU pin		Board function																	
Main function	LQFP144	System	SDRAM	LCD-TFT	LCD-RGB	LCD-SPI	L3GD20	USB	LED	Puchbutton	ACP/RF	Touch panel	Free I/O	Power supply	CN2	CN3	CN6	P1	P2
														GND				64	29
														GND					63
														GND					64

1. If SB27 is On.
2. If SB26 is On.

# 5 Mechanical drawing

Figure 9. STM32F429 Discovery board mechanical drawing

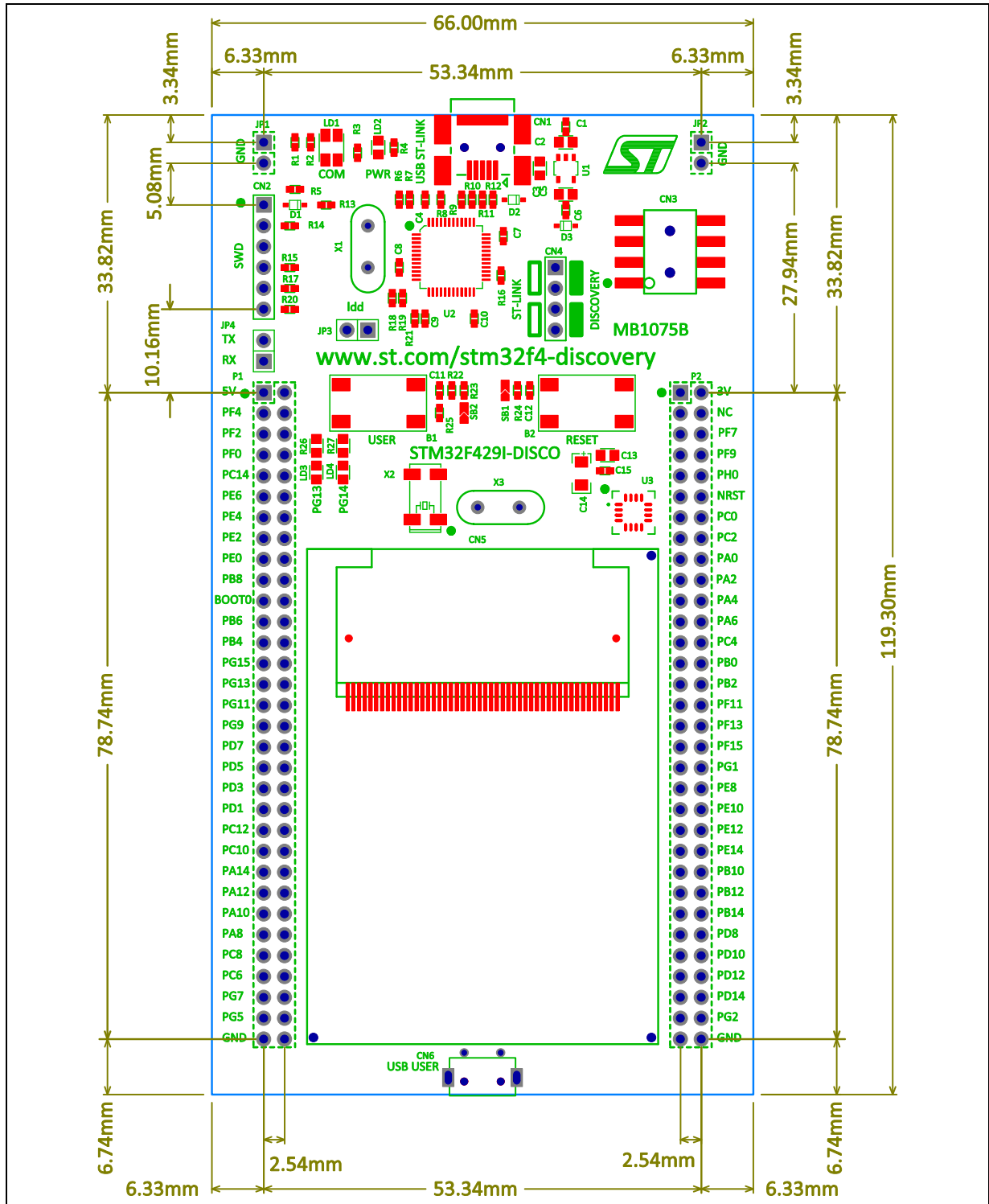

# 6 Electrical schematics

Figure 10. STM32F429 Discovery board

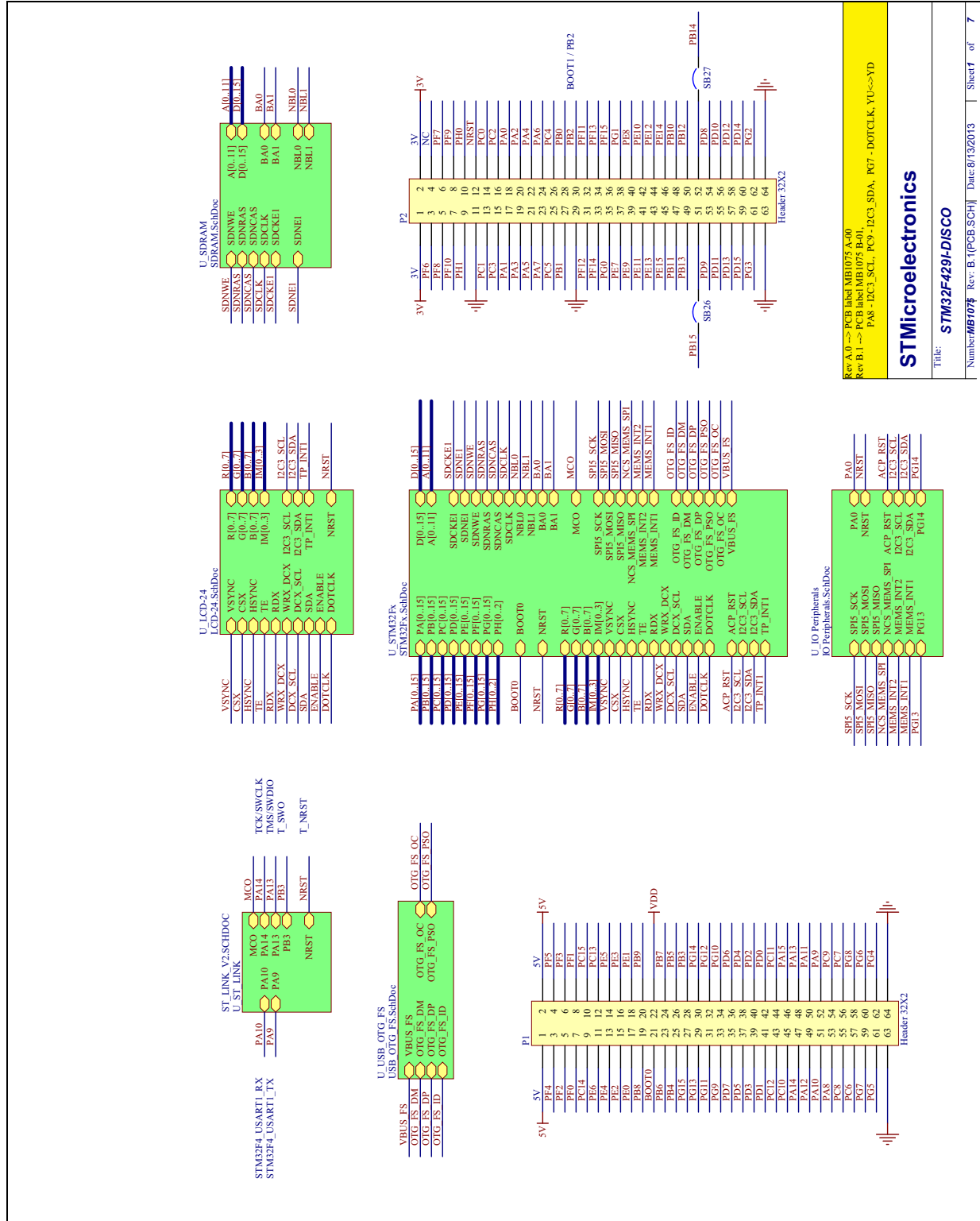

Rev. A.1.1 -> PCB libref:MB1075\_5.00  
 Rev. B.1.1 -> PCB libref:MB1075\_5.00  
 PA8 + I2C3\_SCL, PC9 + I2C3\_SDA, PG7 -> DOTCLK, YU<->YD

**STMicroelectronics**

Title: **STM32F429L-DSICO**

Number **MB1075**, Rev. B.1 (PCB.SCH), Date:8/13/2013 | Sheet **1** of **7**



Figure 11. ST-LINK/V2 (SWD only)

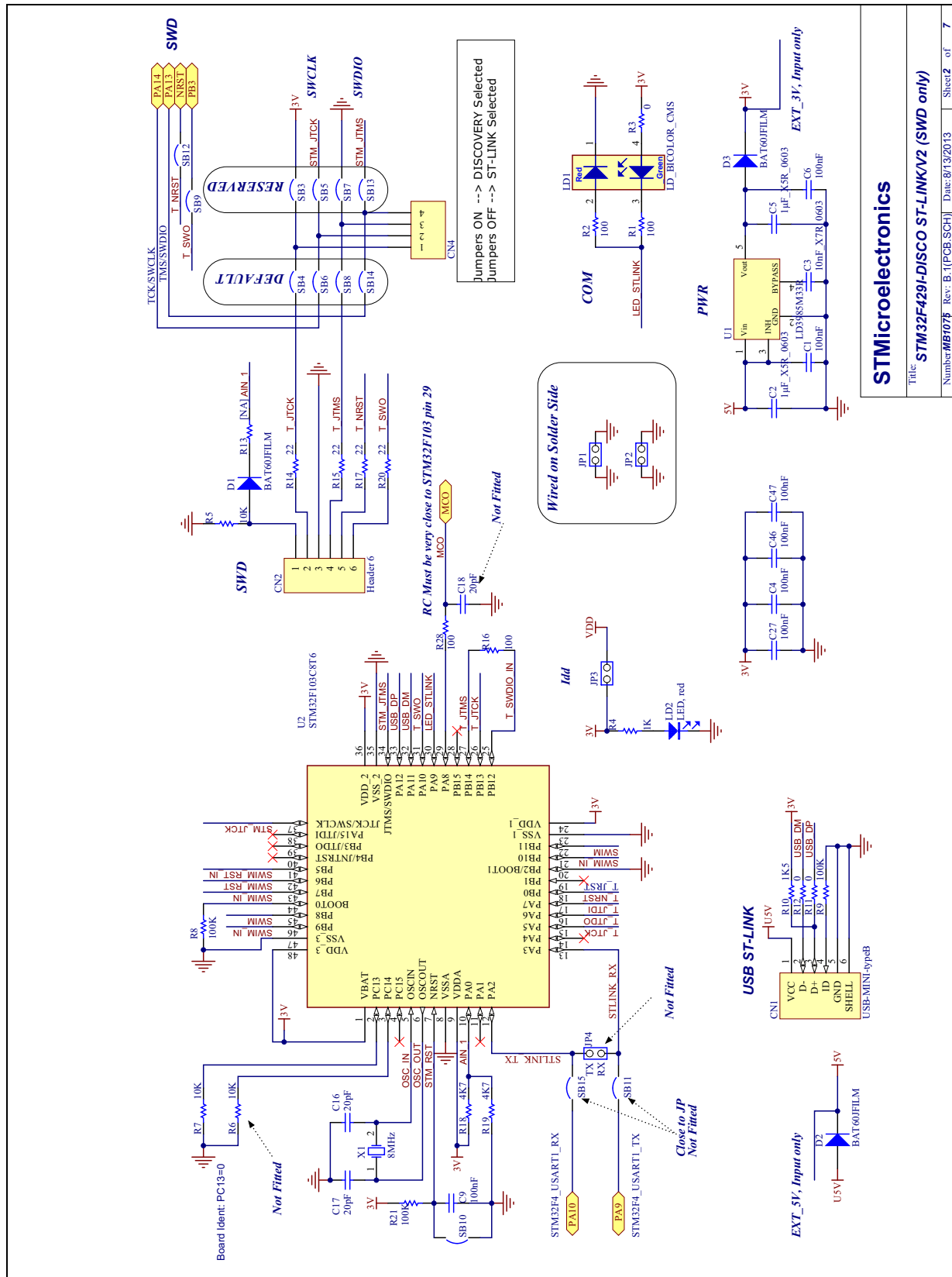

**STMicroelectronics**

Title: **STM32F429I-DISCO ST-LINKV2 (SWD only)**

Number **MB1077**, Rev.: B.1[PCB.SGH], Date: 8/13/2013, Sheet 2 of 7



Figure 12. USB OTG\_FS

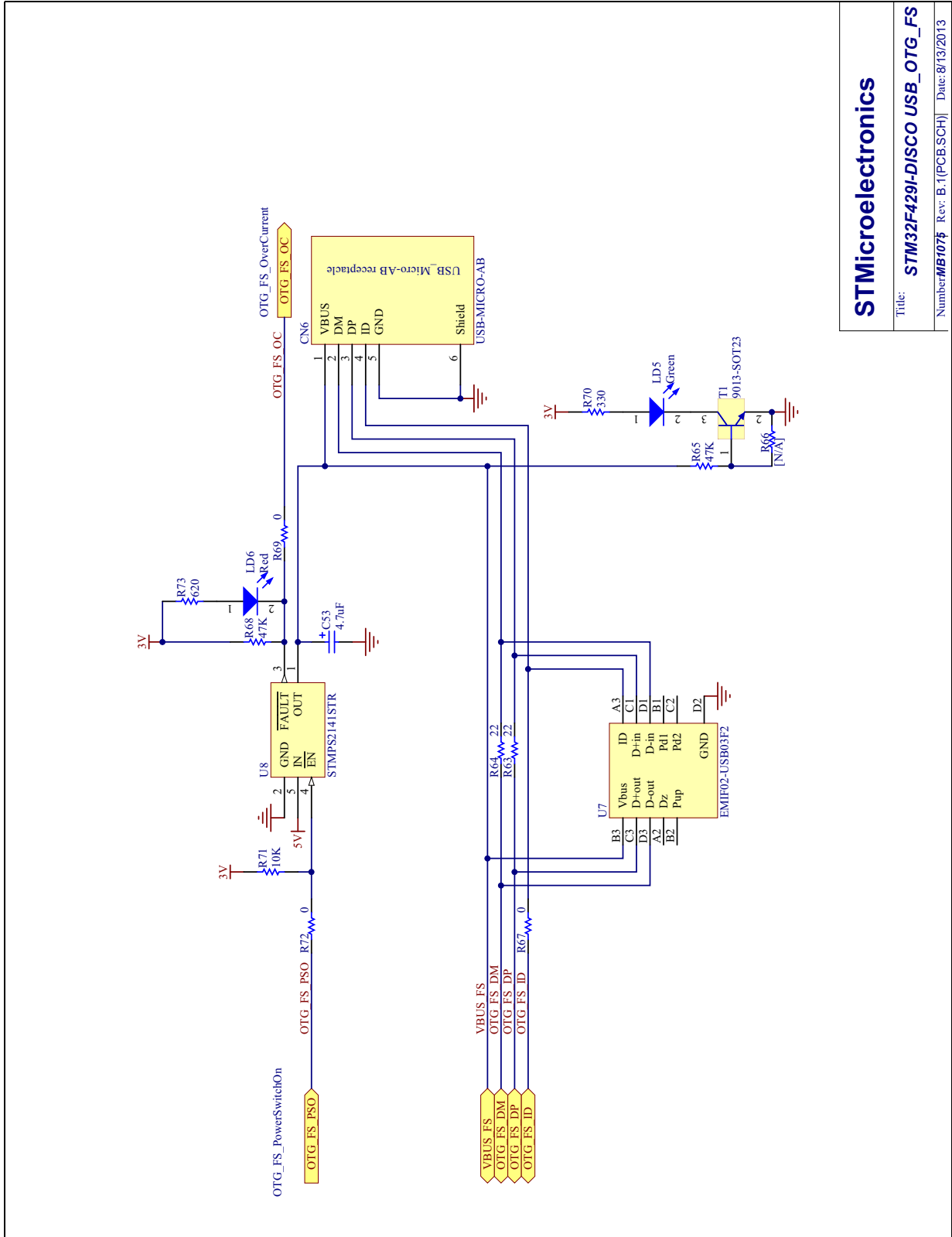

**STMicroelectronics**  
Title: **STM32F429I-DISCO USB\_OTG\_FS**  
Number: **MB1078** Rev: B.1 (PCB.SCH) | Date: 8/13/2013



Figure 13. SDRAM 64 Mbits

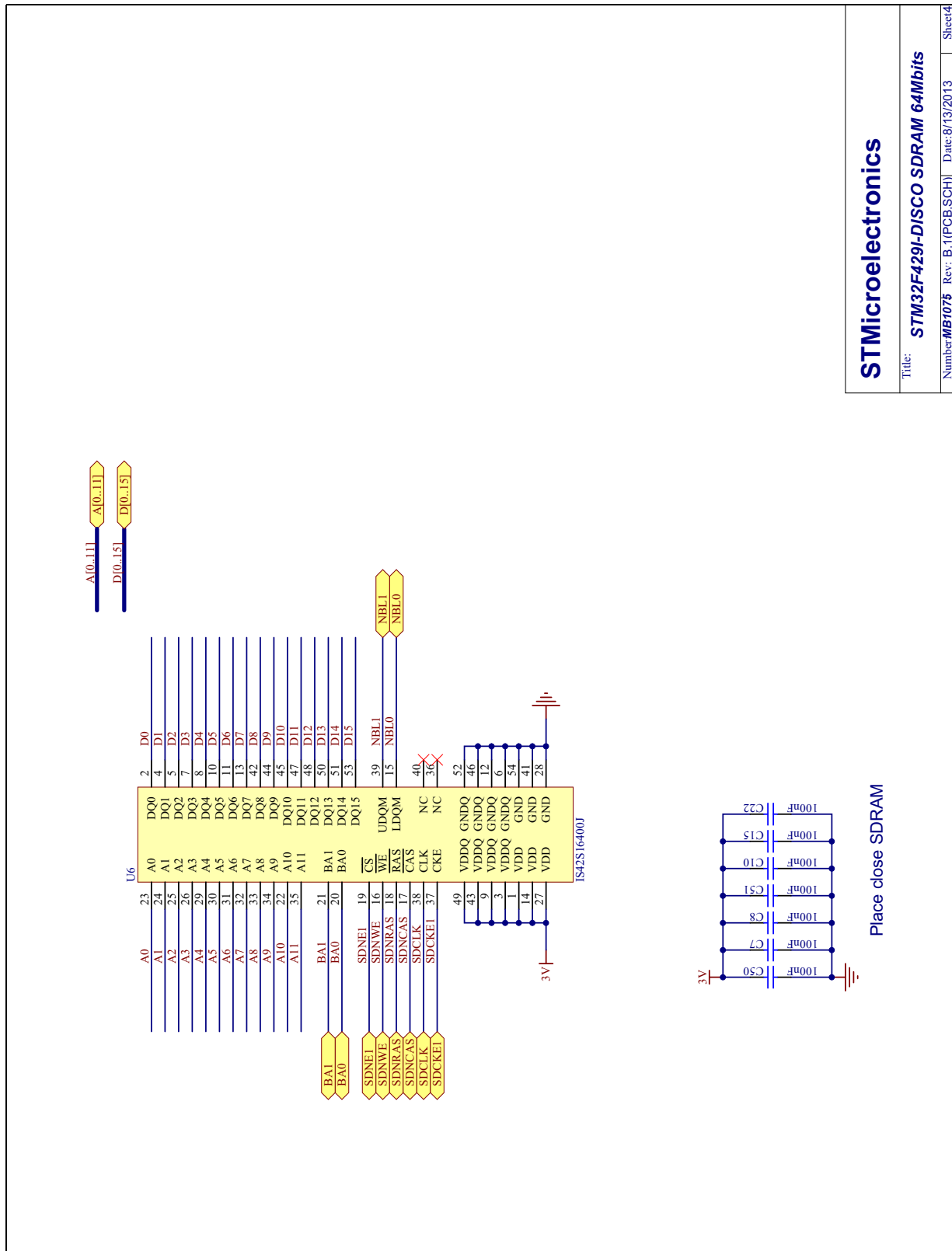

STMicroelectronics

Title: **STM32F429I-DISCO SDRAM 64Mbits**

Number **MB1075** Rev: B.1[PCB.SCH] Date: 8/13/2013 Sheet 4

Figure 14. STM32F429ZIT6 MCU

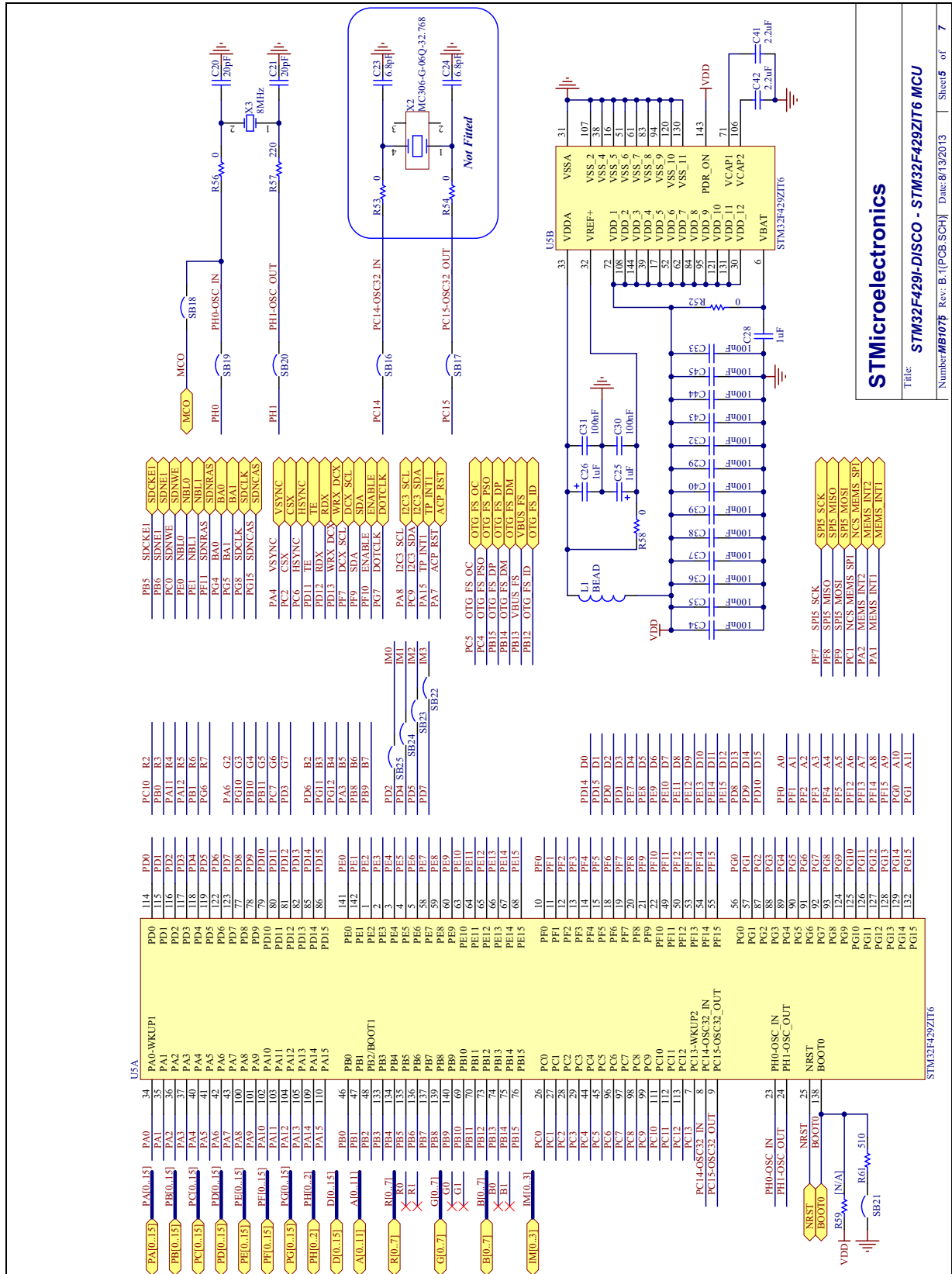

**STMicroelectronics**

Title: **STM32F429I-DISCO - STM32F429ZIT6 MCU**

Number: **MB1077** Rev: B.1(PCB SCH) | Date: 8/13/2013 | Sheet **5** of **7**



Figure 15. Peripherals

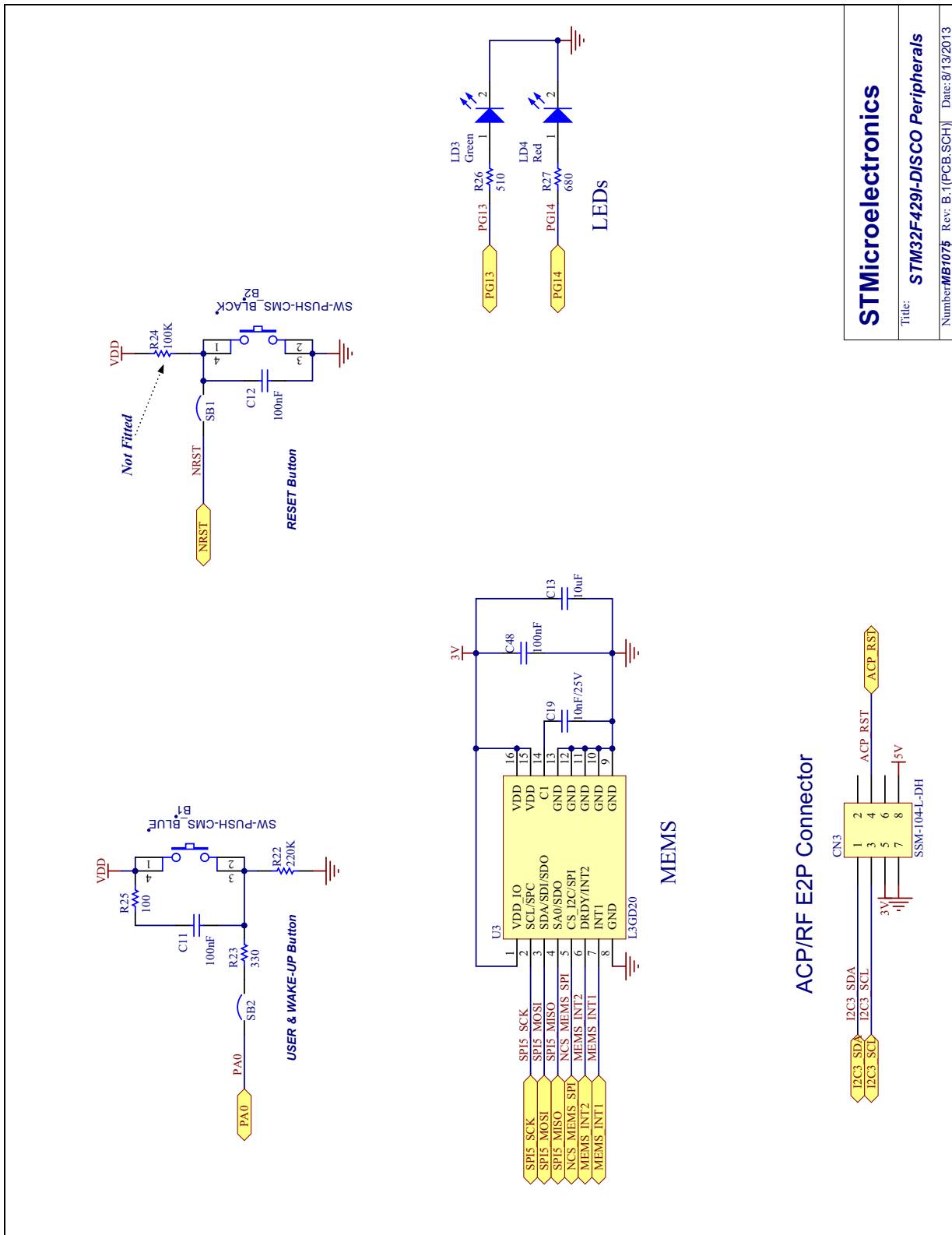

<b>STMicroelectronics</b>	
Title: <b>STM32F429I-DISCO Peripherals</b>	
Number <b>MB1075</b> Rev: B.1[PCB.SCH] Date: 8/13/2013	



Figure 16. LCD 2.4"

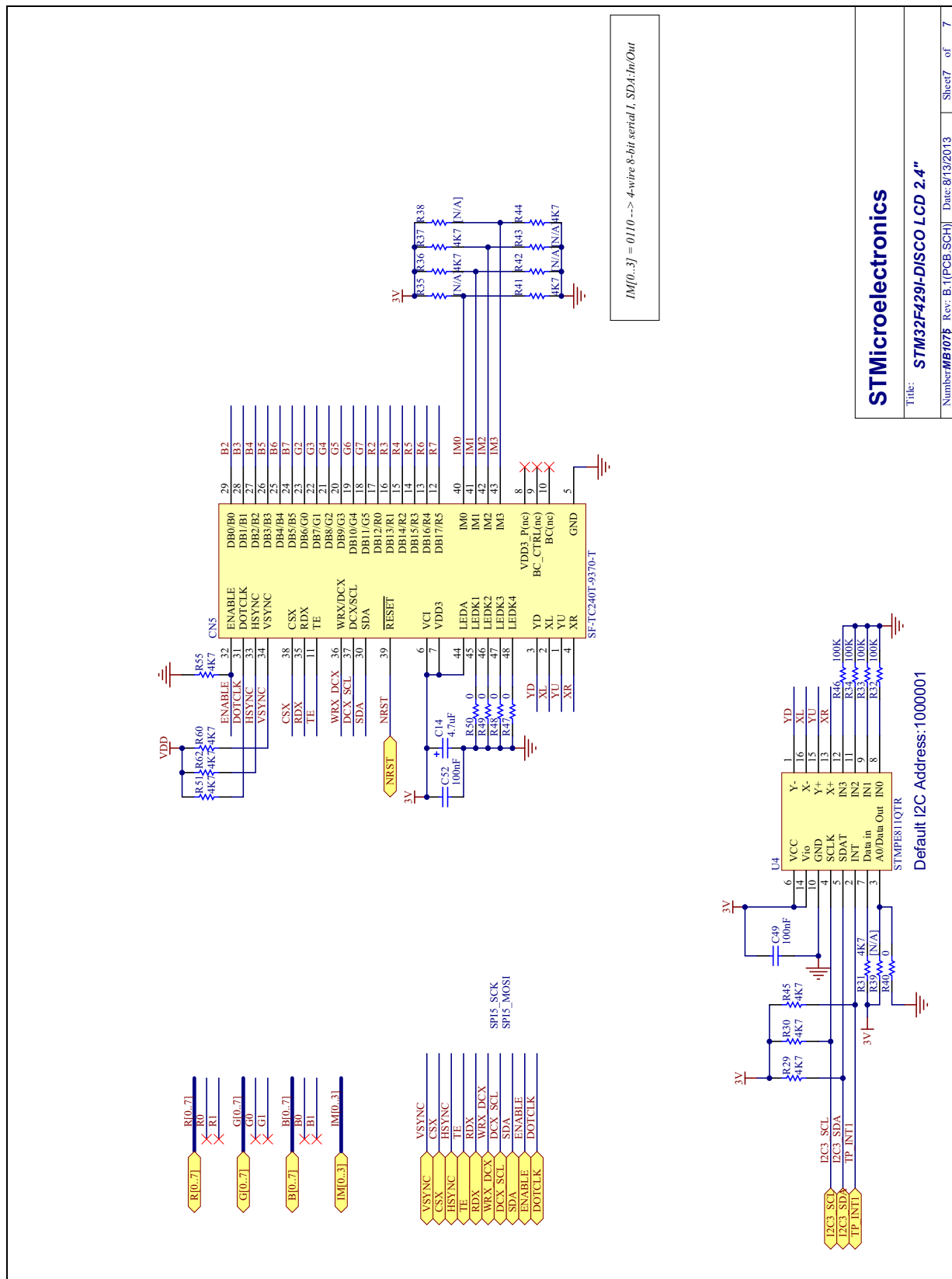

## 7 Revision history

Table 7. Document revision history

Date	Revision	Changes
10-Sep-2013	1	Initial release.

**Please Read Carefully:**

Information in this document is provided solely in connection with ST products. STMicroelectronics NV and its subsidiaries ("ST") reserve the right to make changes, corrections, modifications or improvements, to this document, and the products and services described herein at any time, without notice.

All ST products are sold pursuant to ST's terms and conditions of sale.

Purchasers are solely responsible for the choice, selection and use of the ST products and services described herein, and ST assumes no liability whatsoever relating to the choice, selection or use of the ST products and services described herein.

No license, express or implied, by estoppel or otherwise, to any intellectual property rights is granted under this document. If any part of this document refers to any third party products or services it shall not be deemed a license grant by ST for the use of such third party products or services, or any intellectual property contained therein or considered as a warranty covering the use in any manner whatsoever of such third party products or services or any intellectual property contained therein.

**UNLESS OTHERWISE SET FORTH IN ST'S TERMS AND CONDITIONS OF SALE ST DISCLAIMS ANY EXPRESS OR IMPLIED WARRANTY WITH RESPECT TO THE USE AND/OR SALE OF ST PRODUCTS INCLUDING WITHOUT LIMITATION IMPLIED WARRANTIES OF MERCHANTABILITY, FITNESS FOR A PARTICULAR PURPOSE (AND THEIR EQUIVALENTS UNDER THE LAWS OF ANY JURISDICTION), OR INFRINGEMENT OF ANY PATENT, COPYRIGHT OR OTHER INTELLECTUAL PROPERTY RIGHT.**

**ST PRODUCTS ARE NOT AUTHORIZED FOR USE IN WEAPONS. NOR ARE ST PRODUCTS DESIGNED OR AUTHORIZED FOR USE IN: (A) SAFETY CRITICAL APPLICATIONS SUCH AS LIFE SUPPORTING, ACTIVE IMPLANTED DEVICES OR SYSTEMS WITH PRODUCT FUNCTIONAL SAFETY REQUIREMENTS; (B) AERONAUTIC APPLICATIONS; (C) AUTOMOTIVE APPLICATIONS OR ENVIRONMENTS, AND/OR (D) AEROSPACE APPLICATIONS OR ENVIRONMENTS. WHERE ST PRODUCTS ARE NOT DESIGNED FOR SUCH USE, THE PURCHASER SHALL USE PRODUCTS AT PURCHASER'S SOLE RISK, EVEN IF ST HAS BEEN INFORMED IN WRITING OF SUCH USAGE, UNLESS A PRODUCT IS EXPRESSLY DESIGNATED BY ST AS BEING INTENDED FOR "AUTOMOTIVE, AUTOMOTIVE SAFETY OR MEDICAL" INDUSTRY DOMAINS ACCORDING TO ST PRODUCT DESIGN SPECIFICATIONS. PRODUCTS FORMALLY ESCC, QML OR JAN QUALIFIED ARE DEEMED SUITABLE FOR USE IN AEROSPACE BY THE CORRESPONDING GOVERNMENTAL AGENCY.**

Resale of ST products with provisions different from the statements and/or technical features set forth in this document shall immediately void any warranty granted by ST for the ST product or service described herein and shall not create or extend in any manner whatsoever, any liability of ST.

ST and the ST logo are trademarks or registered trademarks of ST in various countries.

Information in this document supersedes and replaces all information previously supplied.

The ST logo is a registered trademark of STMicroelectronics. All other names are the property of their respective owners.

© 2013 STMicroelectronics - All rights reserved

STMicroelectronics group of companies

Australia - Belgium - Brazil - Canada - China - Czech Republic - Finland - France - Germany - Hong Kong - India - Israel - Italy - Japan - Malaysia - Malta - Morocco - Philippines - Singapore - Spain - Sweden - Switzerland - United Kingdom - United States of America

[www.st.com](http://www.st.com)

